

Improvement of the Fatigue Life of 3D Printed Nano Soft Artificial Heart and Heart Valves

Ali Saad Mahmood*

* saad.m.ali@uotechnology.edu.iq

Biomedical Engineering Department, University of Technology, Iraq

Received: April 2023

Revised: October 2023

Accepted: October 2023

DOI: 10.22068/ijmse.3235

Abstract: In the present work, development models of a new artificial human soft heart and artificial heart valves using nanocomposite materials and synthetics were designed, manufactured, and tested. The fabricated mechanical artificial heart valves were examined to determine the best service life for each type. The fatigue life results were implemented by using the transient repeated and continuously applied blood pressure on each produced value to simulate diastolic and systolic that occur in the natural heart at each pulse cycle. The obtained results showed that a 3D printing of a new generation soft artificial heart for a permanent replacement was implemented as an alternative to the high-cost available temporary implant mechanical hearts, which may exceed the price by tens and hundreds of thousands of dollars, with a working life of not more than five years. The obtained fatigue safety factors for the produced artificial valves using different materials and designs were decreased with the complexity of the movement of the moving parts of the valve. The highest rates were obtained when using the valves with flat, simple movement in one direction like the single-leaflet type valve, where all the used materials are suitable for the production of this type of valve. The highest obtained safety factor was reached (15). The lowest rates were recorded when using the highly flexible and strong PSN4 nanocomposite material for fabricating the mitral tri-leaflet valve (thick. = 1.0 mm) reached 1.91. This value decreases to 0.99 when using the same type and material of valve but with a thickness equal to 0.5 mm. It can be noted here that the only suitable for the manufacture of this artificial valve type is the nanocomposite polyetherimide/ silicone rubber with nano silica (PSN4), whereas the other used materials failed because the fatigue factor values are less than 1. The service life span of this material is about 9200×10^6 cycles, which is equivalent to about 290 years, followed by SIBSTAR 103 with a default age of 209.6×10^6 cycles or 9 years.

Keywords: Artificial Caged Ball valve, Single-leaflet Heart Valves, Soft Artificial Hearts, Heart valves ANSYS simulation, 3D printing Valves, Heart valves Fatigue Life, Tricuspid Aortic Valve.

1. INTRODUCTION

The heart is the most important organ in the human body that keeps us alive. It works to transport blood and supply oxygen to different parts of the body, and if the heart does not work properly, the different organs such as the brain, liver, and kidneys will not receive enough oxygen, which leads to brain death and multiple organ failure. Heart failure affects about 20 million people in the United States and Europe alone. About 900,000 people are diagnosed with heart failure each year in the developed world, and about 600,000 people die annually. The number of people diagnosed with these diseases has also recently increased dramatically, with an increase of 46% between 2012 and 2030 in developing countries, which prompted clinicians to cooperate to find alternative treatments for failing hearts, including complete replacement of the biological heart with mechanical pumps and ventricular support devices to increase patient survival and quality of life [1-2].

In recent years, technological development in cardiac surgery has increased rapidly through advances in tissue engineering by improved mechanical and performance, use of new surgical materials, and decreased use of anticoagulant and immunomodulatory drugs [3]. Advances in tissue engineering and 3D printing along with innovations in surgical techniques have shown great success in developing and manufacturing artificial heart structures as a temporary alternative to the natural heart due to the shortage of organ donors [4-5]. Tissue engineering is an interdisciplinary approach, combining life sciences, materials engineering, and computer modelling to produce and build synthetic tissues for biomedical applications including artificial heart and heart valves manufacturing that must be biocompatible and have sufficient mechanical strength to perform dynamic functions with long lifespan [4, 6-7].

Although significant progress has been made towards improving the design and performance of mechanical heart valves, functional, implantability,

and life remain significant challenges. A wide range of manufacturing, design, and materials technologies have been developed, but this field is still under development, and recent developments in heart valve manufacturing such as additive manufacturing have made it possible to build complex 3D structures according to patients' needs and with specific characteristics [8].

Current developments have shown a rapid increase in the use of 3D printing in medical applications [9-10], which leads to significant advances in industrial production and academic study [11]. 3D printing or additive manufacturing (AM), is an innovative and important rapid manufacturing method based on depositing materials in successive layers according to a specific digital design for creating objects of complex shapes in a short period and at a relatively low cost. AM technique is particularly useful in engineering and medical applications such as rapid prototyping [12]. It is increasingly used in many medical fields, including cardiac surgery with structural cardiac products, vascular, orthopaedics, and maxillofacial surgery, dentistry, drug delivery, and in the production of highly complex indigenous human tissues and organs that can be implanted into the human body [13-14].

The materials used in the manufacture of mechanical heart valves are selected according to their biocompatibility and mechanical properties. The most important materials used for manufacturing flexible valves are polyurethane, poly(styrene-*b*-isobutylene-styrene), polytetrafluoroethylene, and soluble plastics. Solid polymer heart valves are made of poly methyl methacrylate (PMMA) or polyethylene (PE) balls [15]. Whereas, Young's modulus of PMMA (~3 GPa) and PE (~1 GPa), are about 102-105 times higher than the original heart valves (~2-15 kPa) [16].

The current work aims to design, simulate, and manufacture a new soft artificial heart and different types of mechanical artificial heart valves using different synthetic and nanocomposite materials by using ANSYS, SolidWorks, and 3D printing technology. The manufactured valves will be examined to determine the best service life by using the Response Surface Methodology (RSM) and Expert Design 13 system.

2. MATERIALS AND METHODOLOGY

The mechanical prosthetic heart valves are an effective engineering device used to replace the damaged or diseased natural valves of the heart and are characterized by long performance and high reliability, but they may lead to possible complications such as hemolysis and thrombosis [17]. In the current work, five filament materials of 1.75 mm diameters, produced by Torwell Technology were used to fabricate the artificial human total soft hearts and heart valves. These filament materials are; high-quality thermoplastic nylon, and white. It is a durable, strong, corrosion-resistant material, with medium flexibility to resist shocks and high-temperature resistance. It is stronger than ABS/PLA/HIPS, but it is highly sensitive to moisture and should be stored closed. It is a very difficult material to print because it is easily extracted from the bed of the printer. It has been treated by pre-heating and drying for 8 hours at 60°C to remove moisture, bubbles, and warping edges. The heating process was continued throughout the printing process by using a heating device type Creality 3D printer filament heating drying box. For the success of the printing, the work also needed to coat the bed with a thin first layer of non-toxic and washable Stick transparent glue.

The second material that was used is the thermoplastic aliphatic polyester PLA (Polylactic acid). Two PLA materials were used, white and transparent purple. This material is made from renewable resources such as starch or corn, and because of its good adhesion to surfaces, it often does not need a heated bed when printed. Polylactic acid (PLA), is the first synthetic pickle to be produced from annually renewable resources, combines environmental, advantages with excellent performance in a widely used industrial fabric that has replaced conventional polymers and is a leading biomaterial for many medical, pharmaceutical, and packaging applications and household items and clothing [18-21]. The material is characterized by high strength, good toughness, and high stiffness with dimensional stability by heat and low shrinkage. It is easy to print, with high-quality details, and less thermal stresses, but it is also characterized by some brittleness. The other material that was used is the thermoplastic polyethylene terephthalate glycol (PETG), which is blue. The

product manufactured by using the polyethylene terephthalate glycol (PETG) type is very strong, has less shrinkage, and has good adhesion layer properties [22]. PETG filament combines the durability of ABS and the ease of PLA printing with greater flexibility, slight residual stresses, and relatively low shrinkage. It is resistant to chemicals or various solvents and is used for drinks and foods, as it is healthy and safe to use in this regard.

In the past two decades, interest in the dynamic performance of flexible valves for their high durability, and now, polymeric valves have demonstrated their effectiveness [23]. The Thermoplastic Polyurethane (TPU) material was also used. TPU is one of the best options to replace long-lasting artificial heart valves due to its high mechanical stability [24]. It is a high-performance and tough thermoplastic, with thermal stability [25-26]. It also has good mechanical toughness with elastic behaviour, excellent high wear resistance and high tensile strength, good chemical resistance, and machinability [27]. Three filaments of transparent (purple, orange, and yellow) were used. It is a flexible rubber material that allows the printed part to bend and stretch easily, with excellent toughness and good heat resistance up to 80°C. It is similar to TPE but less flexible. The Shore A scale is used to measure a material's "hardness" ranging from 85 A (very flexible) to 95 A (very firm). However, it also has the disadvantage of absorbing moisture, residual stresses, and slow printing.

The last material used in the present work is the flexible thermoplastic polyurethane elastomer TPE, red. It is made of thermoplastic elastomer, which is more difficult to print than TPU because it is more susceptible to tension and blockage, so the thickness of the printing layer shouldn't exceed 0.1 mm to 0.2 mm with a low feed rate, which relieves pressure on the filament and thus does not get stuck. TPEs are of great interest, and an important commercial example is poly(styrene-diene-styrene) block copolymers consisting of 20-40% polystyrene (PS) block sections that have superior thermal stability and oxidation resistance [28-29]. The material is characterized by shock resistance, durability, and variable flexibility.

In the past two decades, interest in the dynamic performance of flexible valves for their high

durability, and now, polymeric valves have demonstrated their effectiveness [23]. Two other silicon-based nano-composite materials were also selected. The first material was the self-assembling thermoplastic polystyrene-isobutylene-b-styrene (SIBSTAR103T) nanostructured rubber linear triblock. SIBS is also a flexible material that has physical properties that overlap with silicone rubber and polyurethane. They are biostable over their lifetime in the body [30-31]. These polymers are used as drug-eluting stent coatings in clinical practice. The as-received pellets of SIBSTAR 103T were supplied by Kaneka Corp. It was produced by a hot compression molded with liquid nitrogen and contained 34.2 (wt%) polystyrene, 107.0 (g/mol) Mn, and 1.34 Mw/Mn [32].

The second material was the nanocomposite-reinforced polyetherimide/silicone rubber with a nano-silica particle (PSN4). It contains 85% polyetherimide (PEI, Ultem 1000) produced by Sabic Innovative Plastic (USA), 15% silicone rubber (VMQ (Silastic NPC-40), produced by Dow Corning, USA), and reinforced with 4% Nano silica modified particles by a melt mixing process, and supplied by Cabot, USA [23]. The printing process was accomplished using the smart Creality 3D printer CR-10. (Table 1) lists the main physical and mechanical properties of the used 3D printing materials.

2.1. ANSYS and SolidWorks Designs of a Total Soft Artificial Heart and Heart Valves

Heart failure (HF) is associated with a wide range of symptoms and is a complex clinical condition that impairs the heart's function as a pump. Heart diseases are the leading cause of death today. Heart failure is considered the end stage of many cardiovascular diseases.

A weak heart shows a high risk of sudden death, and cardiac function is not fully restored until heart transplantation [33]. Heart transplantation is a very restricted option due to the limited number of donor hearts available - currently about 2,800 donors per year in the United States. This need can be met by an artificial heart with better biocompatibility than the ventricle currently used as an assistive device [34]. A total artificial heart (TAH) is a pneumatic replacement heart used as a bridge in heart transplantation [35-36].

Table 1. The main physical and mechanical properties of the used 3D printing filament materials.

Filament materials	Density gm/cm ³	Nozzle temp. °C	Heated bed temp. °C	Printing speed mm/s	Tensile Strength MPa	Tensile Elongation %	Impact Strength KJ/m ²	Flexural Strength MPa	Flexural Modulus GPa
Nylon (White)	1.16	240	85	35	6.37	231.30	28.30	8.34	0.20
PETG (Blue)	1.27	240	75	50	4.90	120.00	8.70	70.61	2.15
(TPU) Transparent (purple, orange, and yellow)	1.21	235	60	40 – 60	16.80	550.00	34.40	1.80	0.08
TPE (Red)	1.14	235	30	20-40	14.00	990.00	-	80.00	1.00
PLA (White and, Transparent purple)	1.24	200	40	50	6.08	4.40	4.20	6.47	2.75
SIBSTAR 103T	0.92	-	-	-	18.10	506.00	-	-	5.92
PSN4	1.27	-	--	-	39.13	108.50	102.60	73.24	2.43

In the current work, a design of a new generation soft artificial heart for a permanent replacement was implemented. It is low in cost and easy to manufacture with low energy consumption. The printed soft heart is an alternative to the temporary implant mechanical hearts, which cost tens and hundreds of thousands of dollars, with a working life of not more than five years. The work has been done on development, design, modelling, and simulation for a real-size human soft heart using the SolidWorks 18.0 and ANSYS 18.0 software. Multiphysics static structural, multifluid flow (CFD), and fluent fluid flow (CFX) analysis systems were used to determine the blood flow dynamics of cardiac performance. For biomechanical performance verification and optimization, the response surface methodology (RSM) and the Design Expert 13.0 were used [37-38].

The blood argument is designed to simulate a normal heart. The width of the entire artificial heart body is 76 mm, while the height from the left atrium to the top of the heart body is 95 mm, and it can supply the body with (5-7) litres/min., which is equivalent to 12 l/min. or 2×10^{-4} m³/s., with a blood pressure ranging from 100 to 400 mmHg.

The simulation of the soft artificial heart was carried out using the Fluid Flow Analysis System (CFX) during the flow cycle activity to determine the dynamic response of the compressed blood on the performance of the designed soft artificial heart, after introducing the mechanical and physical properties of the selected nanomaterials

as a material for the manufacture of the heart body, human blood and air used as a mechanism to move the heart. To calculate the volume of fluid blood that the heart model can pump, static structural analysis and multi-flow fluid (CFD) systems were used, in which the locations of the tricuspid and pulmonary valves were entered as well as for the inlet and outlet valves of the air intake.

The overall size of the designed core is 2.6663 x 105 mm, and its dimensions (width, height, and thickness) are 142.62, 167.38, and 70 mm, respectively. The net weight is 293 gm and with blood and compressed air 577 gm. The estimated production cost of the heart is about 400 US dollars, not including the cost of the implantation process. The designed soft artificial heart can be used as a real permanent replacement for the heart and it is not a temporary bridge like other artificial hearts currently available that are very expensive and have multiple side effects.

(Fig. 1) shows the SolidWorks model for the inner and outer sections of the designed soft artificial heart, while (Fig. 2) shows the 3D models for the right and left ventricles, the air pressure, and the drag zones designed to perform the heart activities.

To determine the fatigue life (in cycles) of the produced valves, the value of endurance limits (S_e') must be found first. For all the designed and printed artificial heart valves, $S_e' = 0,5 \cdot S_{ut}$ the ultimate tensile stress (S_{ut}) [39], and:

$$\text{Modified Endurance Limit } (S_e) = S_e' \cdot k_a \cdot k_b \cdot k_c \cdot k_d \cdot k_e \cdot k_f \quad (1)$$

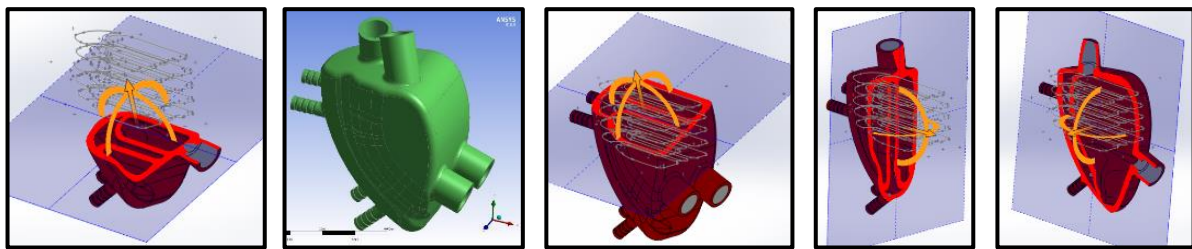

Fig. 1. The Solid work model for the inner and outer sections of the designed soft artificial heart

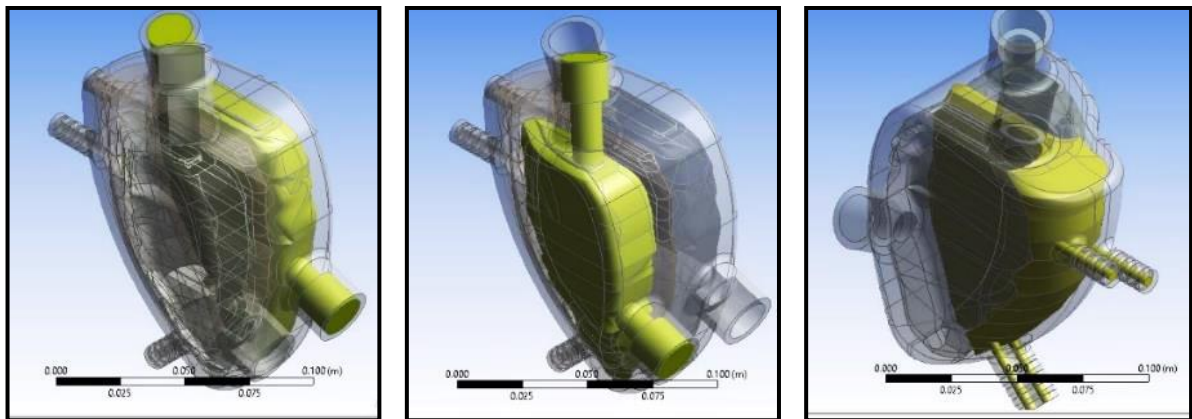

Fig. 2. The 3D models for the designed soft artificial heart; (a) the right and; (b) the left ventricles; (c) the air pressure and drag zones

Where the Surface Condition Factor (k_a) for the grinding surface is equal to:

$$(k_a) = a S_{ut}^b = 1.58 * 6.37^{-0.085} \quad (2)$$

The size factor for bending and torsion (k_b) (assuming the mean diameter of the artificial valves is equal to 25 mm) then:

$$(k_b) = 1,23 d^{-0,107} = 0.872 \quad (3)$$

The loading factor (k_c)= 085 (for axial load). The temperature factor (k_d)= 1 for human life. The reliability factor (k_e)= 0,82 corresponds to 99% reliability and 8% standard deviation of the endurance limit, and using a miscellaneous-effects factor (k_f)= 1. Then, at the given fatigue stress (σ), the fatigue life i.e., the number of cycles to the failure (N) is found as:

$$N = (1/a)^{1/b} \quad (4)$$

Where for $S_{ut} < 490$ MPa; $f = 0.9$, then:

$$a = (f S_{ut})^2 / S_e \quad (5)$$

$$b = -1/3 \log (f * S_{ut} / S_e) \quad (6)$$

To determine the fatigue properties of designed and 3D-printed heart valves, they were first modelled using ANSYS 18.0 and SolidWorks 18.0 software. Then the boundary conditions of each valve were determined, in which a pressure of blood flow from the heart, which is equal to 150 Pa was applied on the valve's moving parts, while the valve base area at the heart assembly

completion was simply supported, as shown in (Fig. 3.)

2.2. The 3D Printing of a Soft Artificial Heart and Heart Valves

3D printing technologies have provided wide options for the manufacture of heart valves of the required quality and complexity. The selection of the appropriate printing material depends on the physiological behavior of the original cardiac tissue, the associated physical and mechanical properties, the time and cost of manufacture, and the type of printer used. The current problem or limitation of 3D functional modelling is its mechanical properties and service life. Continuing cooperation between manufacturers of printed materials and materials scientists will increase the pace of rapid developments in the field of cardiovascular, where it is possible to create 3D printed heart models for use in the planning and simulation of complex cardiac interventions before surgery, in improving clinical decision-making during surgery, in diagnostic work, directing treatment strategies, facilitating circulatory research, procedural simulation, and promoting interventional training [35-38].

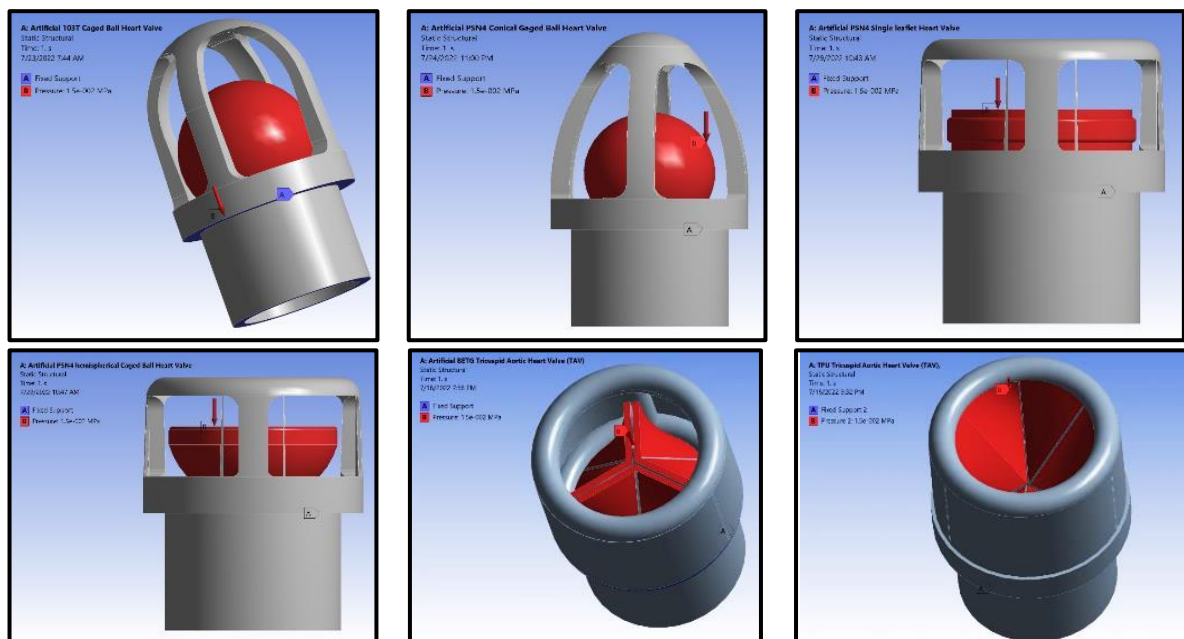

Fig. 3. The boundary conditions of the ANSYS and SolidWorks designed and modelled artificial valves

At this stage, the 3D printing machine has been prepared according to the settings parameters illustrated in (Table 1). The nozzle and bed temperatures and the printing speed were fixed for each filament material that was used, including the Nylon (white), PETG (blue), TPU (transparent purple, orange, and yellow), TPE (red), and PLA (white and, transparent purple). Figure 4 shows the first 3D-printed group of heart valves that were produced to identify the best process parameters for each filament material to guarantee the best durability, flexibility, smoothness, and quality of the moving parts of each valve. In this group, several artificial human valves were printed, including the caged ball valve, the conical caged ball valve, the tricuspid prosthetic aortic valve (TAV), and the mitral tri-leaflet valve.

(Fig. 5) shows the artificial caged ball heart valves that were printed using the selected five filament materials including the PLA white, TPU (transparent purple), TPE (red), and PET (blue) filament materials.

(Fig. 6) shows the 3D printing of artificial conical caged ball heart valves. (Figs. 7 to 10) show the 3D printing of artificial heart valve types single hemispherical leaflets, mitral tri-leaflet, and tri-leaflet heart aortic valve (BAV), respectively. The 3D-printed models of hearts with congenital heart disease can also be utilized in simulation interventional training and diagnostic

catheterization [44-45]. The shape of the artificial heart should mimic the shape of the natural heart and be suitable for the remaining pericardial cavity [46-47].

(Fig. 11) shows the final 3D printed of the designed total soft artificial hearts from a red thermoplastic polyurethane elastomer (TPE), and the transparent orange and purple thermoplastic polyurethane (TPU) filaments materials, respectively. (Fig. 12) shows the installation and assembly of various types of produced heart valves with soft artificial hearts.

3. RESULTS AND DISCUSSION

Table 2 illustrates the fatigue life analysis results for the designed soft artificial hearts for the used Nano composites, using the Goodman ratio loading criteria to simulate the process of diastolic and systolic at each pulse that occurs in the natural heart, where the transient repeated applied air pressure values of a 200 Pa for 0.5 seconds followed by an absorption air pressure of -50 Pa for 0.3 seconds were used.

These results show that the fatigue life values increase with increasing the tensile strength and decreasing the percentage elongation, reaching its maximum value as 3.65×10^{13} cycles, when using the polyetherimide/silicone (PSN4) Nano-composite elastomers.

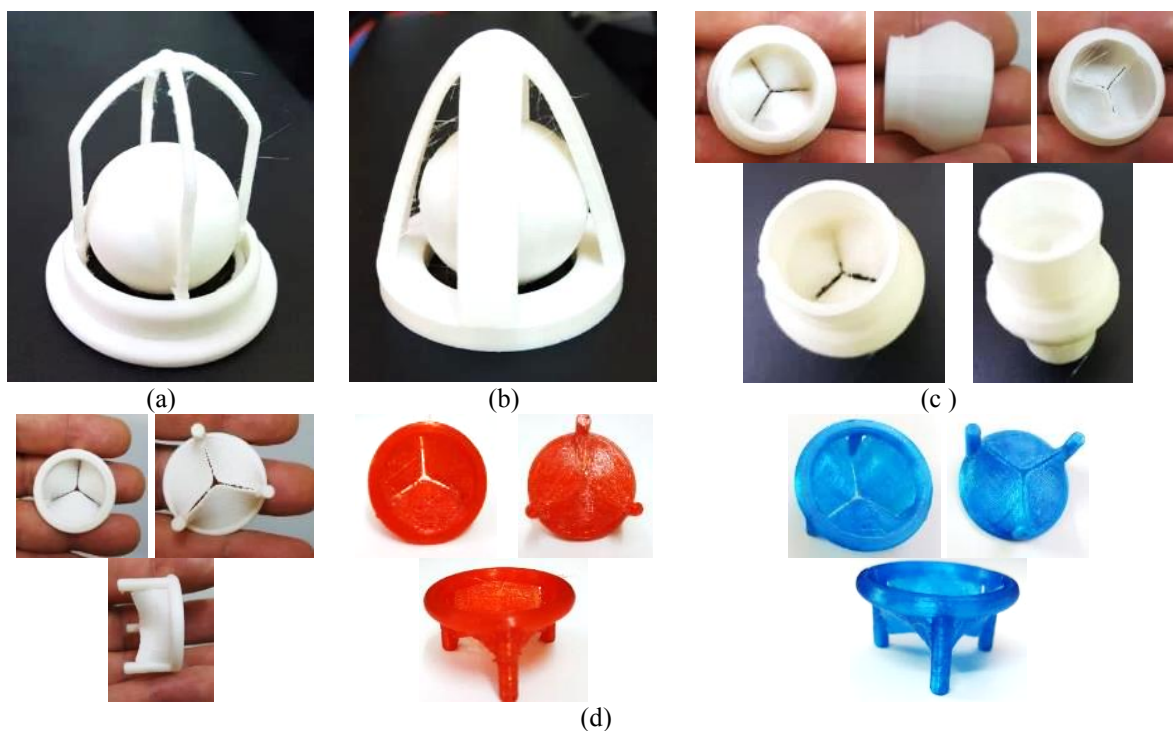

Fig. 4. The first 3D printed group of heart valves; (a) Caged ball valve; (b) Conical caged ball valve; (c) Artificial bicuspid aortic valve (BAV); (d) Artificial Mitral Tri-Leaflet Valve



Fig. 5. The 3D printed artificial caged ball heart valves; PLA white; TPU transparent purple; TPE red; PETG blue



Fig. 6. The 3D printing of an artificial conical caged ball heart valves.



Fig. 7. The 3D printing of artificial single leaflet mechanical heart valve

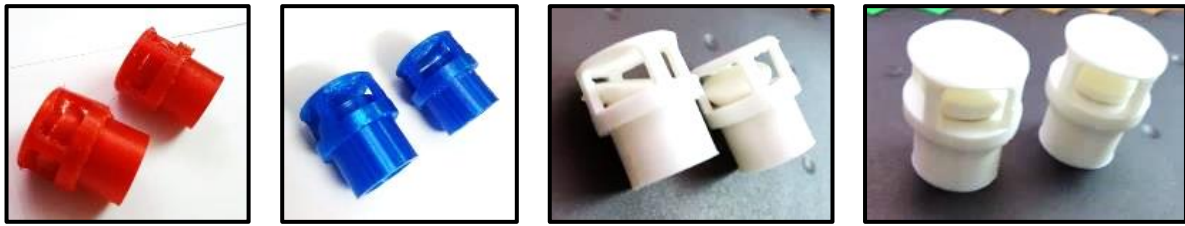

Fig. 8. The 3D printing of artificial single hemispherical leaflet mechanical heart valve



Fig. 9. The 3D printing of artificial mitral tri-leaflet mechanical heart valve



Fig. 10. The 3D printing of artificial tri-leaflet heart aortic valve (TAV) mechanical heart valve



Fig. 11. The final 3D print of the designed total soft artificial hearts from a red TPE, and the transparent orange and purple TPU filaments materials, respectively.



Fig. 12. The installation and assembly of various types of produced heart valves with soft artificial hearts.

Table 2. The fatigue life analysis results for the designed soft artificial hearts for the used Nanocomposites

Item	Nanocomposite material	Fatigue Life (Cycle)	Fatigue Safety Factor	Fatigue Life (Years)
1-	VMQ/ZDMA; 100/30	1.36×10^7	5.14	0.34
2-	30% SiO ₂ / RTV-1 SiR	1.70×10^7	5.14	0.42
3-	Silicone rubber+12% magnetite	4.05×10^8	5.14	10.09
4-	Silicone Rubber (Polysiloxane)	2.31×10^9	5.68	57.52
5-	PDMS/20% HAp composites	5.61×10^9	6.28	139.7
6-	SIBSTAR 103T	3.99×10^{11}	10.54	~
7-	PSN4	3.65×10^{13}	15.00	~

(Table 3) illustrates the fatigue safety factor of the designed artificial heart valves. (Figs. 13 and 14) show the ANSYS models and simulation of the fatigue life and the fatigue safety factor for selected types and the used materials of the designed artificial heart valves by using the Goodman loading ratio criteria to analyze the results, the statistical Expert Systems 13.0 program was used. (Fig. 15) represents the obtained fatigue safety factors for the produced valve materials and for different designed artificial valve types, where the obtained values decrease with the complexity of the movement of the moving parts of the valve. The highest rates were obtained when using the valves with flat, simple movement in one direction like the single-leaflet type valve, where all the used materials are suitable for the production of this type of valve, and the highest obtained safety factor, was reached (15). The lowest rates were recorded when using the highly flexible and strong PSN4 nanocomposite material for fabricating the mitral tri-leaflet valve (thick.= 1.0 mm) reached 1.91. This value decreases to 0.99 when using the same type and material of valve but with a thick.= 0.5

mm. It is noted here that the only suitable for the manufacture of this artificial valve type is the PSN4 material, whereas the other used materials failed because the fatigue factors values are less than 1.

(Fig. 16a) shows the values of fatigue life resulting from applying blood pressure during the diastole and contraction cycles of the heart for all the used materials for the manufacture of artificial heart valves estimated in 106 cycles, while (Fig. 16b) shows the same service lives estimated in years (assuming that one heart work cycle is completed in approximately every one second). From the figure, it is clear that the best material suitable for the manufacture of artificial heart valves is the nanocomposite polyetherimide/silicone rubber with nano silica (PSN4). The service life span of this material is about 9200×106 cycles, which is equivalent to about 290 years, followed by material 103 with a default age of 209.6×106 cycles or 9 years. (Table 4) illustrates the calculated fatigue lives for the used 3D printing filament materials.

More work is needed on the performance of the flexible polymeric heart valve to determine its

long-term durability for implantation [8, 23]. Polymeric valves represent an attractive alternative to current alternatives, as they provide superior durability and hemodynamic function to valves. However, it may fail prematurely due to fatigue under periodic loading and still cause thrombosis and calcification. A final exception to this trend is valves with polyurethane base leaflets that have been demonstrated to be used in non-calcification aortic valve replacement [48-49].

4. CONCLUSIONS

The main conclusions of this work can be summarized in the following:

- 1- In the current work, a 3D printing of a new generation soft artificial heart for a permanent replacement was implemented.

- 2- The printed soft heart is an alternative to the temporary implant mechanical hearts, which cost tens and hundreds of thousands of dollars, with a working life of not more than five years.
- 3- The work has been done on development, design, modeling, and simulation for a real-size human soft heart using the SolidWorks 18.0 and ANSYS 18.0 software.
- 4- The obtained fatigue safety factors for the produced valve materials and different designed artificial valve types decrease with the complexity of the movement of the moving parts of the valve.
- 5- The highest rates were obtained when using the valves with flat, simple movement in one direction like the single-leaflet type valve, where all the used materials are suitable for the production of this type of valve, and that highest obtained safety factor, was reached (15).

Table 3. The fatigue safety factor of the designed artificial heart valves.

Artificial Heart Valve Type	Material	Fatigue Safety Factor (Min.)	Artificial Heart Valve Type	Material	Fatigue Safety Factor (Min.)
Caged Ball	PETG	1.007	Tricuspid Aortic Valve (TAV), (Tricuspid Thick.= 0.5 mm)	PETG	0.135
	PLA	1.468		PLA	0.199
	Nylon	1.668		Nylon	0.226
	TPE	4.170		TPE	0.564
	TPU	4.700		TPU	0.632
	SIBSTAR 103T	5.671		SIBSTAR 103T	0.609
	PSN4	9.340		PSN4	1.264
Conical Caged Ball	PETG	0.927	Tricuspid Aortic Valve (TAV), (Tricuspid Thick.=1.0 mm)	PETG	0.115
	PLA	1.360		PLA	0.169
	Nylon	1.546		Nylon	0.192
	TPE	3.864		TPE	0.480
	TPU	4.328		TPU	0.537
	SIBSTAR 103T	4.173		SIBSTAR 103T	0.518
	PSN4	8.655		PSN4	1.075
Single-leaflet	PETG	9.991	Mitral Tri-leaflet Valve (Tri-leaflet Thick.= 0.5 mm)	PETG	0.106
	PLA	14.653		PLA	0.156
	Nylon	15		Nylon	0.177
	TPE	15		TPE	0.460
	TPU	15		TPU	0.495
	SIBSTAR 103T	15		SIBSTAR 103T	0.478
	PSN4	15		PSN4	0.991
Single Hemispherical Leaflet	PETG	1.724	Mitral Tri-leaflet Valve (Tri-leaflet Thick.= 1.0 mm)	PETG	0.204
	PLA	2.529		PLA	0.300
	Nylon	2.874		Nylon	0.341
	TPE	7.184		TPE	0.852
	TPU	8.333		TPU	0.954
	SIBSTAR 103T	7.76		SIBSTAR 103T	0.920

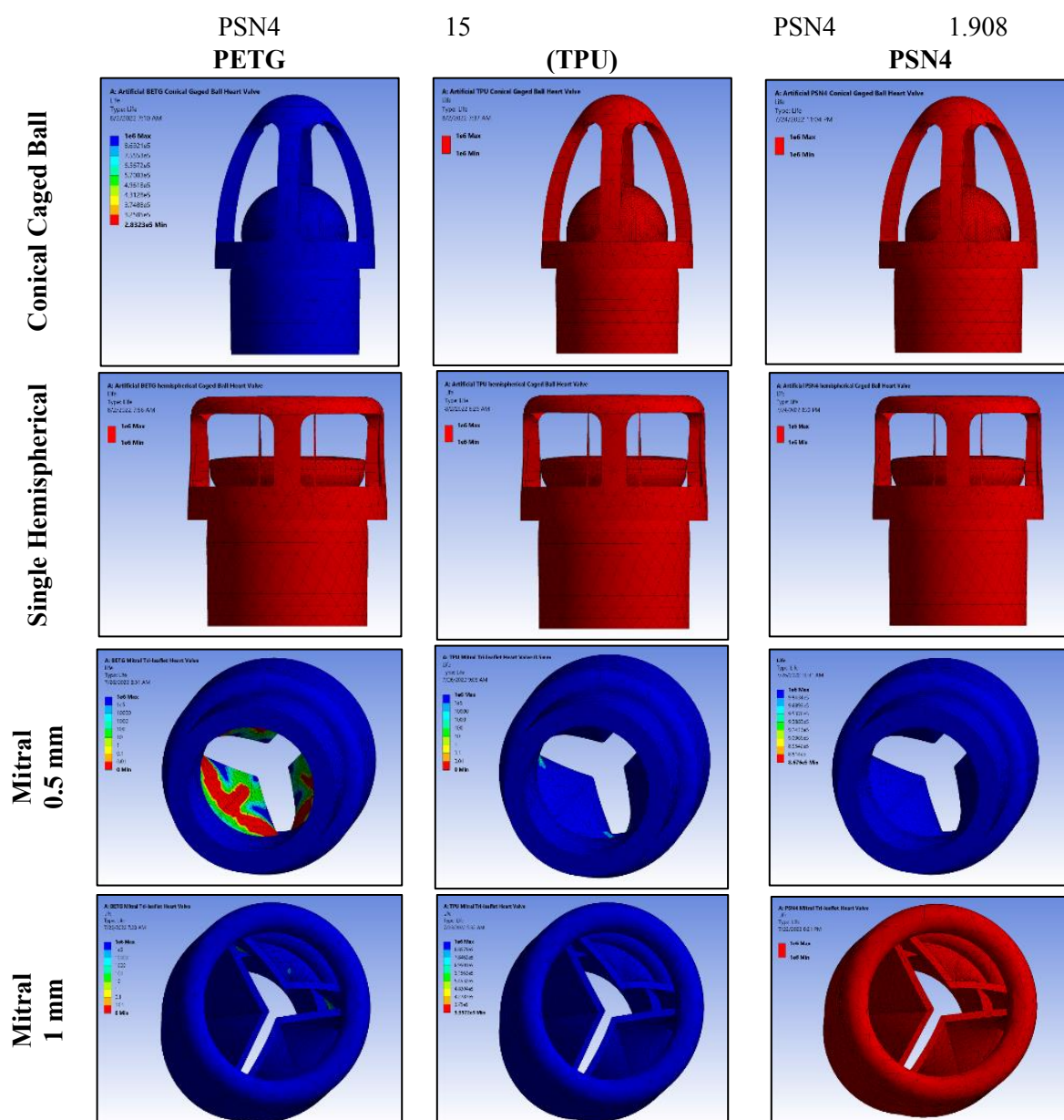

Fig. 13. The fatigue life simulation for selected types and the used materials of the designed and artificial heart valves

Table 4. The calculated fatigue lives for the used 3D printing filament materials.

Filament materials	UTS (Mpa)	Endurance limits (Se ⁻¹) (Mpa)	Modified Endurance limits (Se) (Mpa)	Constants		Fatigue Life	
				a	b	(1*10 ⁶)	Years
PETG	4.9	2.45	0.93	20.91	-0.223	0.83	0.03
PLA	6.08	3.04	1.16	25.81	-0.223	2.14	0.07
Nylon	6.38	3.19	1.21	27.25	-0.223	2.73	0.09
TPE	14.00	7.00	2.66	59.68	-0.223	91.91	2.91
(TPU)	16.80	8.40	3.19	71.67	-0.223	208.88	6.62
SIBSTAR 103T	18.10	9.05	3.44	77.14	-0.223	299.55	9.50
PSN4	39.13	19.57	7.44	166.70	-0.223	9201.04	291.76

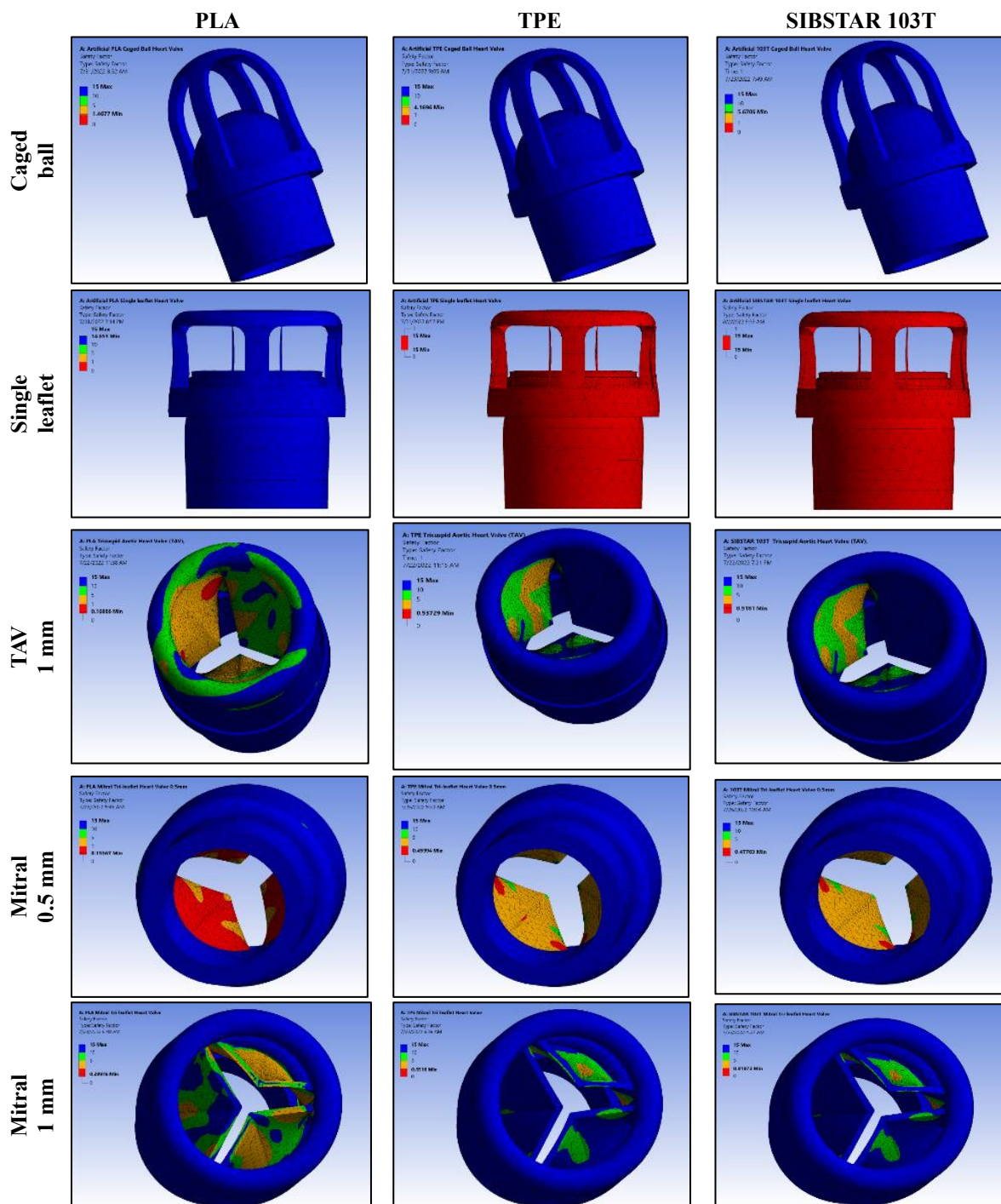

Fig. 14. The fatigue safety factor simulation for selected types and the used materials of the designed artificial heart valves

6- The lowest rates were recorded when using the highly flexible and strong PSN4 nanocomposite material for fabricating the mitral tri-leaflet valve (thick.= 1.0 mm) reached 1.91. This value decreases to 0.99 when using the same type and material of valve but with a

thick.= 0.5 mm.
7- It is noted here that the only suitable for the manufacture of this artificial valve type is the PSN4 material, whereas the other used materials failed because the fatigue factors values are less than 1.

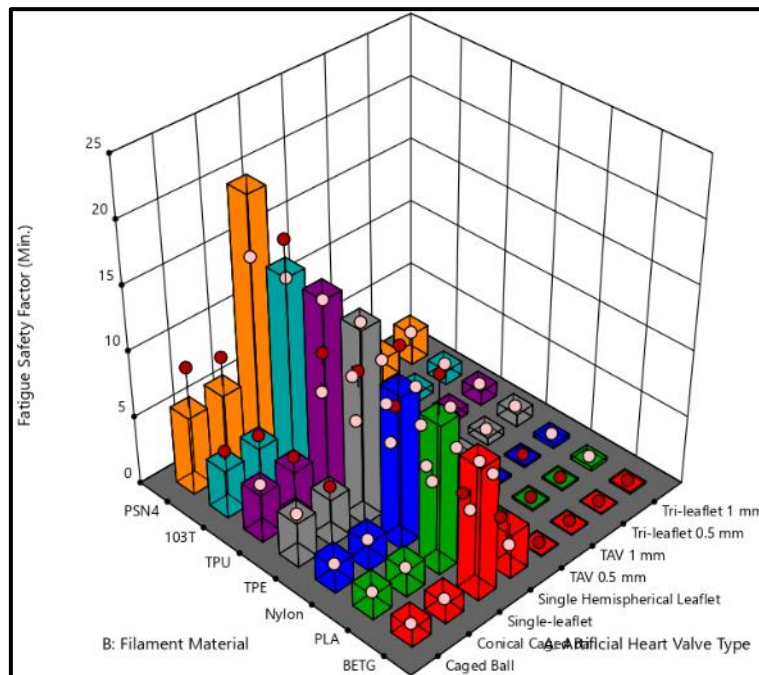

Fig. 15. The produced fatigue safety factor for artificial heart valve types and the used materials

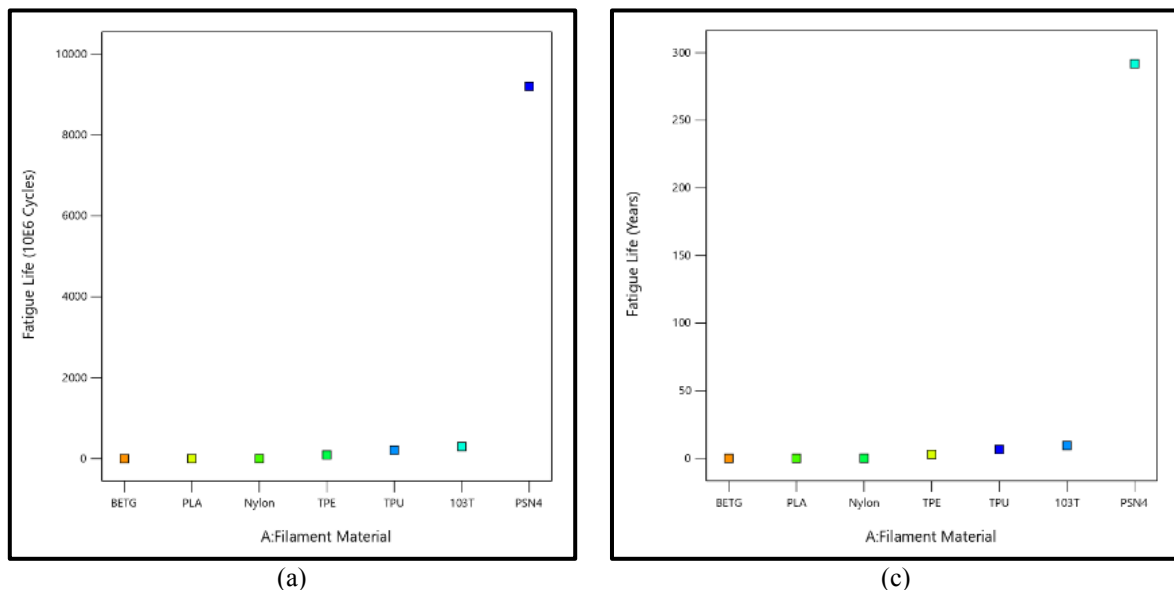

Fig. 16. The fatigue life for each used filament material: (a) in 10⁶ cycles; (b); in years

8- The values of fatigue life resulting from applying blood pressure during the diastole and contraction cycles of the heart for all the used materials show that the best material suitable for the manufacture of artificial heart valves is the nanocomposite polyetherimide/silicone rubber with nano silica (PSN4). The service life span of this material is about 9200×10^6 cycles, which is equivalent to about 290 years, followed by material 103 with a default age of 209.6×10^6 cycles or 9 years. Table 3

illustrates the calculated fatigue lives for the used 3D printing filament materials.

REFERENCES

- [1]. Eleonora D. S., Andrea B., Silvia T. G., Gino G., "The Biocompatibility Challenges in the Total Artificial Heart Evolution", *Annu. Rev. Biomed. Eng.* 2019.21, 85-110.
- [2]. Sanna K., Waqas J., "Evolution of

- Artificial Hearts: An Overview and History”, *Cardiol. Res.*, 2014, 5, (5), 121-125.
- [3]. Liliana F. C, Guilherme O. R., Clarissa G. R., Felipe L. B., Maria C. I., “Using a 3D printer in cardiac valve surgery: a systematic review”, *Irev. Assoc. Med. Bras.*, 2019, 65(6), 818-824.
- [4]. Muhammad Q., Farhan H., Min-Hee K., Jin-H. K., “3D printing approaches for cardiac tissue engineering and role of immune modulation in tissue regeneration”, *International Journal of Nanomedicine*, 2019, 14, 1311–1333.
- [5]. M. Singh, Z. A. Sporn, H. V. Schaff, P. A. Pellikka, “ACC/AHA Versus ESC Guidelines on Prosthetic Heart Valve Management JACC Guideline Comparison”, *Journal of the American College of Cardiology*, 2019, 73, 13, 1707-1718.
- [6]. P. K. Schaefermeier, D. Szymanski, F. Weiss, P. Fu, T. Lueth, C. Schmitz, B. M. Meiser, B. Reichart, R. Sodian, “Design and Fabrication of Three-Dimensional Scaffolds for Tissue Engineering of Human Heart Valves”, *Eur. Surg. Res.*, 2009, 42, 49–53.
- [7]. Thomas C. F. and Abhay P., “Living Artificial Heart Valve Alternatives: A Review”, *European Cells and Materials*, 2003, 6, 28-45.
- [8]. Zhan S., Guo A. X., Cao S. C., Liu N., “3D Printing Soft Matters and Applications: A Review”, *Int. J. Mol. Sci.*, 2022, 23, 3790, 1-13.
- [9]. Cappello I. A., Candelari M., Pannone L., Monaco C., Bori E., Talevi G., Ramak R., La Meir M., Gharaviri A., Chierchia G. B., et al., “3D Printed Surgical Guide for Coronary Artery Bypass Graft: Workflow from Computed Tomography to Prototype”, *Bioengineering*, 2022, 9, 179, 1-9.
- [10]. Volkan T. and Peter M. A., “3D printing for heart valve disease: a systematic review”, *European Radiology Experimental*, 2019, 3, 9, 1-10.
- [11]. Philippe P., Jean G. D., “Prosthetic Heart Valves Selection of the Optimal Prosthesis and Long-Term Management FRCP(C)”, *Circulation*, 2009, 119, 1034-1048.
- [12]. Ksawery S., Wojciech C., Dymitr O., “Selected mechanical properties of PETG 3-D prints”, *Procedia Engineering*, 2017, 177, 455-461.
- [13]. Mohd J., Abid H., “3D printed tissue and organ using additive manufacturing: An overview”, *Clinical Epidemiology and Global Health*, 2020, 8, 586-594.
- [14]. H. Wang, H. Song, Y. Yang, Q. Cao, Y. Hu, J. Chen, J. Guo, Y. Wang, D. Jia, S. Cao and Q. Zhou, “Three-dimensional printing for cardiovascular diseases: from anatomical modeling to dynamic functionality”, *BioMed Eng.*, 2020, 19, 76, 1-16.
- [15]. Jagannathana D, Adarsha H, Ramaiah K, Prabhud R. “A Systematic Study on Mechanical Properties of CNT Reinforced HDPE Composites Developed Using 3D Printing”. *IJMSE 2023*; 20 (3), 1-16.
- [16]. F. Oveissi, S. Naficy, A. Lee, D.S. Winlaw, F. Dehghani, “Materials and manufacturing perspectives in engineering heart valves: a review”, *Materials Today Bio*, 2020, 5, 1-20.
- [17]. W. L. Gao, Z. Jin and J. Qian, “Transient Study of Flow and Cavitation Inside a Bileaflet Mechanical Heart Valve”, *Appl. Sci.* 2020, 10, 2548, 1-13.
- [18]. O. Avinc, A. Khoddami, “Overview of Poly (Lactic Acid) (PLA) Fiber Part I: Production, Properties, Performance, Environmental Impact, and End-use Applications of Poly (lactic acid) Fibres”, *Fibre Chemistry*, 2009, 41, 6, 391-401.
- [19]. X. Pang, X. Zhuang, Z. Tang and X. Chen, “Polylactic acid (PLA): Research, development and industrialization”, *Biotechnol. J.* 2010, 5, 1125-1136.
- [20]. Polyzos E., Pyl L., “Effect of Printing Direction on the Elastic Properties of 3D-Printed Nylon Materials”, *Phys. Sci. Forum*, 2022, 4, 21, 1-8.
- [21]. Dehghani Firoozabadi F, Ramazani Saadatabadi A, Asefnejad A. “Fabrication and Evaluation of in Vitro Studies of Biodegradable and Antibacterial Composite Scaffolds Based on Polylactic Acid-Polycaprolactone-Hydroxyapatite Reinforced with Graphene and Zinc Oxide Nanoparticles for Use in Orthopedic Surgery”. *IJMSE 2022*; 19 (2), 1-19.



- [22]. C. V. Subbarao, Y. Srinivasa R., Vamsi I. M., Indra R., “Dynamic Mechanical Analysis of 3D Printed PETG Material”, *IOP Conf. Series: Materials Science and Engineering*, 2021, 1057, 012031, 1-12.
- [23]. Fausten B, Franke A, Groetzner J, Klosterhalfen B, Messmer BJ, “Introduction of a flexible polymeric heart valve prosthesis with special design for mitral position”. *Circulation*, 2003, 108, Suppl 1: II, 134-139.
- [24]. Z. S. Kazerouni, M. Telloo, A. Farazin, S. Saber-Samandari, E. Sheikhbahaei, B. Kamyab-Moghadas, H. Joneidi -Yekta, S. Esmaeili, A. Khandan, “A Mitral Heart Valve Prototype Using Sustainable Polyurethane Polymer: Fabricated by 3D Bioprinter, Tested by Molecular Dynamics Simulation”. *AUT Journal of Mechanical Engineering*, 2021, 5, 1, 109-120.
- [25]. J. Wang, B. Yang, X. Lin, L. Gao, T. Liu, Y. Lu and R. Wang, “Research of TPU Materials for 3D Printing Aiming at Non-Pneumatic Tires by FDM Method”, *Polymers*, 2020, 12, 1-19.
- [26]. Ghadirian H, Golshahi H, Bahrami S, Najafi F, Geramy A, Heidari S. “Synthesis and Characterization of a Urethane Dimethacrylate Monomer Containing a Quaternary Ammonium Salt for Use as a Component of Orthodontic Adhesive Primer”. *IJMSE* 2022; 19 (2), 1-13.
- [27]. R.F. Storey, D.W. Baugh, K.R. Choate, Poly(styrene-*b*-isobutylene-*b*-styrene) block copolymers produced by living cationic polymerization I. Compositional analysis, *Polymer*, 1999, 40, 3083–3090.
- [28]. Leonard P., Gregory J. W., James J. B., Richard T. S., Jean-Marie P., Joseph P. K., “Medical applications of poly(styrene-block-isobutylene-block-styrene) (“SIBS”), *Biomaterials*”, 2008, 29, 4, 448-460.
- [29]. Seyedmajidi S, Seyedmajidi M. “Fluorapatite: A Review of Synthesis, Properties and Medical Applications vs Hydroxyapatite”. *IJMSE* 2022; 19 (2):1-20.
- [30]. Goy T L, Stephanie A V, Cherie R, Mary M E, Judit E P, Walter I H, Steven P S, “New biomaterial as a promising alternative to silicone breast implants”, *Journal of the mechanical behavior of biomedical materials*, 2013, 21, 47– 56.
- [31]. Mohammed Hamoudi A, Choubani K, Ben Rabha M. “Multicrystalline Silicon Passivation by Hydrogen and Oxygen-Rich Porous Silicon Layer for Photovoltaic Cells Applications”. *IJMSE* 2023; 20 (2), 36-42.
- [32]. Mishra R M and Rai J S P, “Polyetherimide (PEI)/Silicone Rubber Composite Reinforced with Nanosilica Particles”, *International Journal of Scientific and Technology Research*, 2016, 5, 3, 176-180.
- [33]. Carolina G. M., Cristina P. V., Santiago R., Carolina S. B. and Antoni B. G., “Cardiac Tissue Engineering and the Bioartificial Heart”, *Rev. Esp. Cardiol.* 2013, 66, 5, 391–399.
- [34]. M. S. Lundberg, J. T. Baldwin and D. B. Buxton, “Building a bioartificial heart: Obstacles and opportunities”, *The Journal of Thoracic and Cardiovascular Surgery* c, 2017, 153, 748-750.
- [35]. J. A. Cook, K. B. Shah, M. A. Quader, R. H. Cooke, V. Kasirajan, K. K. Rao, M. C. Smallfield, I. Tchoukina, D. G. Tang, “The total artificial heart”, *Journal of Thoracic Disease*, 2015, 7, 12, 2172-2180.
- [36]. M. L. Goodwin, and N. A. Mokadam, “Total Artificial Heart Implantation: How I Teach It”, *Ann Thorac Surg.*, 2019, 108, 1271-1276.
- [37]. Saad M. A., Zahraa J. A., and Mays M. A., “Design and Modeling of a Soft Artificial Heart by Using the SolidWorks and ANSYS”, *Materials Science and Engineering*, 2020, 671, 1-21.
- [38]. Abid Haleem, Mohd J., Anil S., “Additive manufacturing applications in cardiology: A review”, *The Egyptian Heart Journal*, 2018, 70, 433–441.
- [39]. Shigley J E, Mischke C R, “Mechanical Engineering Design”, 2006, McGraw-Hill Inc., 8th ed.
- [40]. Marija V., Dragoslava P. V., Jane K. G., and Stephen H. L., “Patient-specific 3D Valve Modeling for Structural Intervention”, *Structural Heart*, 2017, 1, 5–6, 236–248.
- [41]. Yiting F., Randolph H. L., Alex P. L., “Three-dimensional printing in structural heart disease and intervention”, *Annals of*

- Translational Medicine, 2019, 7, 20, 579, 1-13.
- [42]. Chiara G., Letizia F., Christian L., Juan C. C., Dinko M. and Barbara Z., “Recent Applications of Three-Dimensional Printing in Cardiovascular Medicine”, *Cells*, 2020, 9, 742, 1-33.
- [43]. Rajat V., Prasoon K., Arun K. D., Naveen S., Deepak C. and Pratyosh S., “Quest for cardiovascular interventions: precise modeling and 3D printing of heart valves”, *Journal of Biological Engineering*, 2019, 13,12, 1-12.
- [44]. Carina H., Andre J., Anja T., Maximilian G., Nikolaus T., Barbara B., Alisa T. and Nikolaus A. H., “Design and 3D printing of variant pediatric heart models for training based on a single patient scan”, *3D Printing in Medicine*, 2021, 7:25, 1-11.
- [45]. Marija V., Bobak M., James K. M., Stephen H. L., “Cardiac 3D Printing and its Future Directions”, *Cardiovascular Imaging*, 2017, 10, 2, 171-184.
- [46]. H. Noda, S. Kyo, R. Omoto, “Development of a Totally Implantable Artificial Heart Saitama Medical School Type Total Artificial Heart: STAHT”, *J. Saitama Med. School*, 2004, 31, 73-81.
- [47]. D. S. Petukhov, S. V. Selishchev, and D. V. Telyshev, “Total Artificial Heart: State of the Art”, *Biomedical Engineering*, 2015, 49, 4, 193_196.
- [48]. R. M. Mishraa and J. S. Raib, “Preparation and properties of nanocomposites based on polyetherimide (PEI)/silicone rubber reinforced with halloysite nanotubes”, *Indian Journal of Pure & Applied Physics*, 2018, 56, 787-791.
- [49]. F. B. Coulter, M. Schaffner, J. A. Faber, A. Rafsanjani, R. Smith, H. Appa, P. Zilla, D. Bezuidenhout, and A. R. Studart, “Bioinspired Heart Valve Prosthesis Made by Silicone Additive Manufacturing”, *Matter*, 2019, 1, 266-279.